

# Hurricanes and Severe Storms

Important recommendations for protecting  
your vessel against hurricane damage  
from INAMAR



**INAMAR®**

*Recreational Marine Insurance*

an ACE USA company

# Hurricanes and Severe Storms

Since 1792, INAMAR, through its affiliated company INA (Insurance Company of North America), has been providing insurance coverage for marine interests. This experience has taught us the importance of loss prevention and loss control.

As a special courtesy, INAMAR is providing you with this exclusive publication dealing with hurricanes and severe storms.

We hope you will find it both interesting and informative.

## Table of Contents

• General Hurricane Information	3
Severe Weather Terms	3
Saffir/Simpson Scale	3
• General Precautions for Boat Owners	4
Trailerable Boats	4
Nontrailerable Boats in Dry Storage	5
Nontrailerable Boats in Wet Storage	5
Boats Remaining in Marina Berth	5
• Nautical Knots	6
• Specific Precautions for Boat Owners	6
Prior to the Hurricane Season	6
Prior to the Hurricane	8
During the Hurricane	9
After the Hurricane	9
• Specific Precautions for Marina Owners	10
Prior to the Hurricane Season	10
Prior to the Hurricane	11
During the Hurricane	12
After the Hurricane	12
• Tying to Cleats and Pilings	13
• General Procedures to Process Vessel Claims	14
• Summary	15

# General Hurricane Information

Hurricane! The word is both feared and respected by knowledgeable mariners and old timers along the U.S. coastal areas of the Gulf of Mexico and the Atlantic Ocean. Residents of Southeast Florida are constantly alert to the news of tropical storms developing in or headed for the Atlantic Ocean, the Caribbean Sea or the Gulf of Mexico. This interest is at its highest during the official hurricane season which runs from June 1 to November 30.

A hurricane is a violent tropical cyclone, with winds of 74 or more miles per hour, which spirals counterclockwise around a relatively calm center known as the "eye" of the storm. At full strength, hurricane winds can gust to more than 200 miles per hour as far out as 20 to 30 miles from the eye. Winds of 39 mph and greater can extend 200 miles or more in advance of the hurricane and trail hundreds of miles behind. The greatest threat from hurricane wind is flying debris. Winds also may disrupt electrical power, telephone service, gas, fresh water supplies and transportation. Tornadoes are also possible as a spinoff of the hurricane's wind.

The greatest danger of the hurricane, however, is from the storm surge. As the storm approaches and moves across a coastline, storm surge may rise 10 feet or more above normal high tide and usually is accompanied by battering waves which will overcome coastal lowlands. In addition, extensive rainfall associated with the storm may cause widespread flooding further inland. More than 23 inches of rainfall in 24 hours have been recorded in association with a hurricane.

During the hurricane season, the National Hurricane Center (NHC) in Miami maintains a constant watch for tropical disturbances which could develop into destructive storms.

When it appears that a storm is developing, an Air Force reconnaissance aircraft, or one of the National Oceanic & Atmospheric Administration's (NOAA) research aircraft is sent to the area to make a thorough investigation.

Once a disturbance becomes a depression, the National Hurricane Center will begin issuing advisories. When the depression reaches tropical storm strength, it will be given a name. Advisories then are issued every six hours and indicate the storm's location, intensity, speed and direction of travel. As a hurricane moves toward the mainland, the NHC may issue advisories more frequently.

## Severe Weather Terms in Common Use

- **Advisory**—A message is released by the hurricane center, usually at 6-hour intervals, updating information on the storm or hurricane, including watches and warnings whenever they are in effect. A special advisory is a message given any time there is significant change in weather conditions, or a change in warnings previously released. An intermediate advisory updates information in advisories at 2- to 3-hour intervals, whenever a watch or warning is in effect.
- **Hurricane**—A tropical cyclone that rotates counterclockwise with sustained winds of 74 mph or greater.
- **Hurricane Season**—June 1 through November 30 is officially designated as hurricane season.
- **Hurricane Warning**—A hurricane is expected to strike within 24 hours with sustained winds of 74 mph or more accompanied by heavy rain and high waves.
- **Hurricane Watch**—The alert given when a hurricane poses a threat to a certain coastal area within 36 hours.
- **Severe Depression**—A circulation at the surface of the water with a sustained wind speed of 38 mph or less.
- **Small Craft Warnings**—When a hurricane or tropical storm threatens a coastal area, small craft are advised to remain in port and not to venture into the open sea.
- **Storm Surge**—A rise in tide caused by a hurricane as it moves over or near the coastline. It can be much higher than the normal tidal rise, with breaking waves on top.
- **Tropical Storm**—Distant circulation with sustained wind speeds of 39 to 73 mph.
- **Tropical Storm Warning**—A tropical storm is expected to strike within 24 hours with sustained winds of 39 to 73 mph.

## Saffir/Simpson Scale

Hurricanes are classified by wind strength known as the Saffir/Simpson Scale.

Category	Wind
I	74 - 95 mph
II	96 - 110 mph
III	111 - 130 mph
IV	131 - 155 mph
V	156 + mph

# General Precautions for Boat Owners

The keys to protecting your boat from hurricanes or any severe weather are planning, preparation and timely action. The following precautions and checklists are meant as guides only. Each boat owner needs a plan unique to the type of boat, the local boating environment, the severe weather conditions likely to occur in that region and the characteristics of safe havens and/or plans for protection. The following preparations and precautionary suggestions are issued as guidelines to be used by the marine community. While these suggestions may not be applicable to everyone in all instances, it is hoped that common sense and good judgment will prevail. Should even one of these suggestions save a life, prevent an injury or reduce property damage, our purpose will have been served.

## Prior to the hurricane season:

1. Develop a detailed plan of action to secure your vessel in the marina (if permitted), remove your boat from the threatened area or take your boat to a previously identified storm refuge. Specifically identify and assemble needed equipment and supplies. Keep them together and practice your plan to ensure it works before the hurricane season.
2. Arrange for a friend to carry out your plans if you are out of town during the hurricane season.
3. Check your lease or storage rental agreement with the marina or storage area. Know your responsibilities and liabilities as well as those of the marina.
4. Consolidate all records including insurance policies, a recent photo of your vessel, boat registration, equipment inventory, the lease

agreement with the marina or storage area and telephone numbers of appropriate authorities, i.e., Harbor Master, Coast Guard, insurance agent, National Weather Service, etc., and keep them in your possession. You may need these telephone numbers handy when you return to check on your boat after the hurricane.

5. Maintain an inventory of both the items removed and those left on board. Items of value should be marked so that they can be readily identified.
6. Analyze how you will remove valuable equipment from the boat and how long it will take, so you will have an accurate estimate of the time and work involved. When a hurricane is impending, and after you have made anchoring or mooring provisions, remove all movable equipment such as canvas, sails, dinghies, radios, cushions, biminis and roller furling sails. Lash down everything you cannot remove such as tillers, wheels, booms, etc. Make sure the electrical system is cut off unless you plan to leave the boat in the water, and remove the battery to eliminate the risk of fire or other damage.

In addition to these general steps, which should be taken no matter where you plan to leave your boat during a hurricane or severe weather, the following specific steps should be taken depending on the option you select.

## Trailerable Boats

1. Determine the requirements to load and haul your boat to a safer area. Be sure your tow vehicle is capable of properly and adequately moving the boat. Your trailer tires, bearings and axle all should be in good condition. Too often a flat tire, frozen bearings or a broken axle will prevent an owner from moving a boat.
2. Lash your boat to the trailer once you arrive at a "safe" place, and place blocks between the frame members and the axle inside each wheel. The blocks will prevent damage to the springs from the additional weight of the water. After consulting with the manufacturer, owners of lightweight boats may wish to let about half the air out of the tires, then fill the boat one-third full of water to help hold it down. Consult with the manufacturer prior to performing this procedure.
3. Secure your boat with heavy lines to fixed objects. Try to pick a location that will allow you to secure it from four directions, because hurricane winds rotate and change direction. It can be tied down to screw anchors secured in the ground.

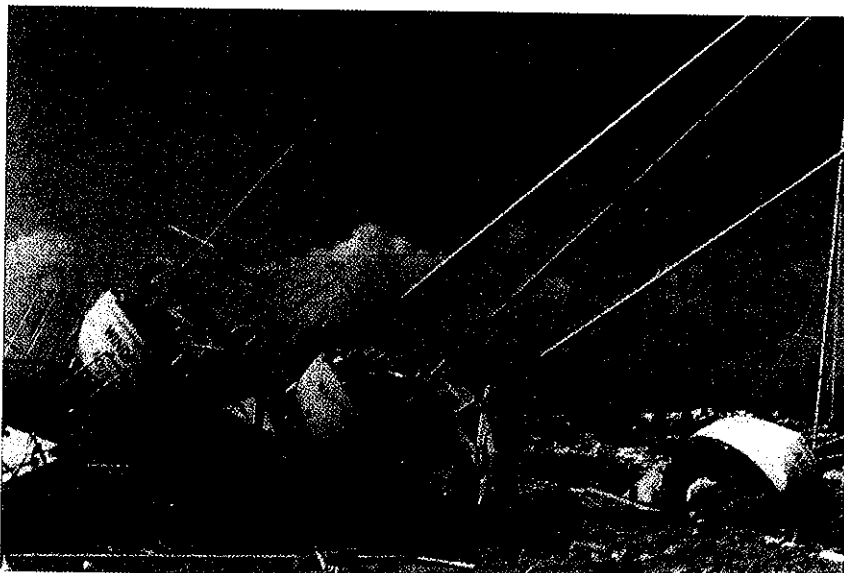

Accidents can happen to boat owners who do not take proper precautions.

## Nontrailerable Boats in Dry Storage

1. Determine the safest and most realistic haven for your boat, and make arrangements to move it there. When selecting a "safe" location, be sure to consider whether storm surge could rise into the area. Wherever you choose to locate your boat for the duration of the hurricane, lash the boat to its cradle with heavy lines and, based on the weight of the boat, consider adding water to the bilge to help hold it down. Consult with the manufacturer prior to performing this procedure.
2. Never leave a boat in davits or on a hydrolift.

## Nontrailerable Boats in Wet Storage

The owner of a large boat, usually one moored in a berth, has three options:

1. Secure the boat in the marina berth.
2. Moor the boat in a previously identified safe area.
3. Haul the boat.

Each action requires a separate strategy. Another alternative – running from the storm – is not encouraged, except for large commercial vessels.

## Boats Remaining in Marina Berth

1. Double all lines. Rig crossing spring lines fore and aft. Attach lines high on pilings to allow for tidal rise or surge. Make sure lines will not slip off pilings. Inspect pilings and choose those that seem strongest and tallest, and that are installed properly.

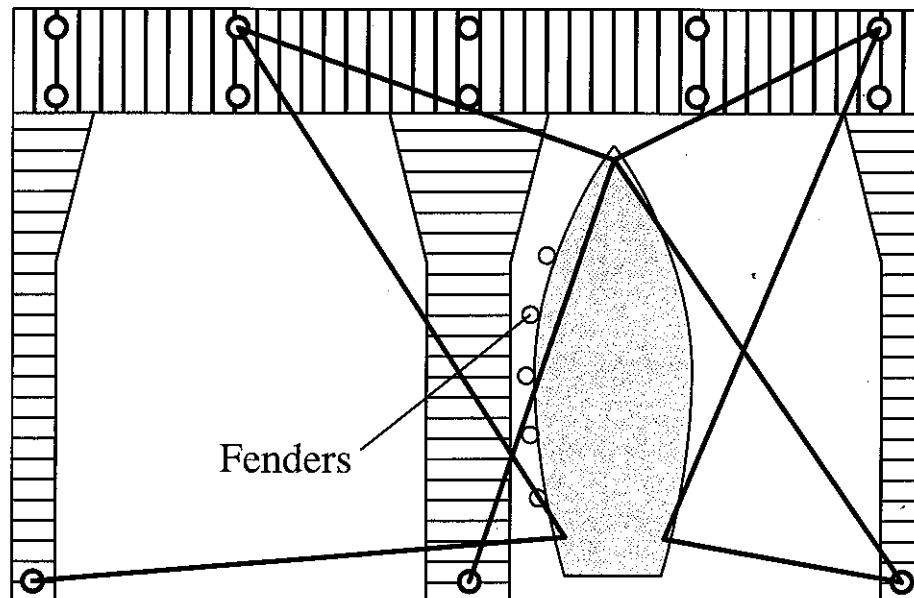

The longer the docklines, the better a boat will be at coping with high tides. It is also essential to double up on all lines and use chafe protectors at any potential chafe points.

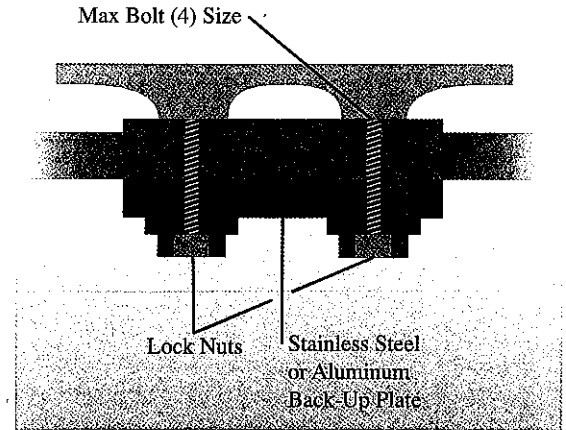

Reinforced and properly backed cleat: note the washers and the backing plate. These are essential in a severe storm, and a good idea in quieter times as well.

2. Cover all lines at rough points to prevent chafing. Wrap with tape, rags and rubber hoses, etc. Install fenders to protect the boat from rubbing against the pier, pilings and other boats.
3. Assess the attachment of primary cleats, winches and chocks. These should have substantial back plates and adequate stainless steel bolt sizes.
4. Fully charge the batteries and check to ensure their capability to run automatic bilge pumps for the duration of the storm. Consider backup batteries. Cut off all devices consuming electricity except bilge pumps.
5. Do not stay aboard. Winds, during any hurricane, can exceed 100 mph and tornadoes are often associated with these storms. First and foremost, safeguard human life.

# Nautical Knots

Figure eight



Square or reef knot

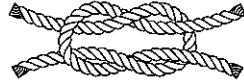

Bowline



Two half hitches

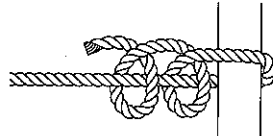

Sheep shank

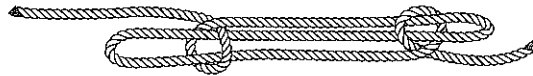

## Specific Precautions for Boat Owners

Marine facilities, marine-related service organizations and insurance companies consider it reasonable to expect a boat owner to take the time and effort to plan necessary actions to secure and protect the vessel. The following recommendations should be considered in formulating an overall hurricane plan for your vessel. Necessary arrangements should be made in advance. If you will be away, a captain or caretaker should be designated to carry out your plan.

### Prior to the Hurricane Season

1. Make sure your vessel is in sound condition. This includes the hull, deck hardware, rigging, ground tackle, machinery and electronics. Absentee owners should arrange for a boatyard haulout, or a supervised inspection of the vessel prior to, and in preparation for, the hurricane season. This includes

making sure that batteries are charged, bilge pumps are operable and all equipment is secured.

2. Enhance the watertight integrity of your boat, both above and below the water line. Seal windows, doors and hatches with duct tape, if necessary. Shut sea cocks and cap off or plug unvalved through-hull fittings such as sink drains.
3. Inspect the vessel's deck hardware in light of planned mooring arrangements. Assess the size and structural attachment of the primary chocks, cleats, bits, bollards and winches. These high-load/high-stress points should have substantial backing plates and be secured with bolts of adequate size.
4. Special attention should be given to avoid chafing of mooring lines. Chafing gear that has been proven successful is a double neoprene hose arrangement.

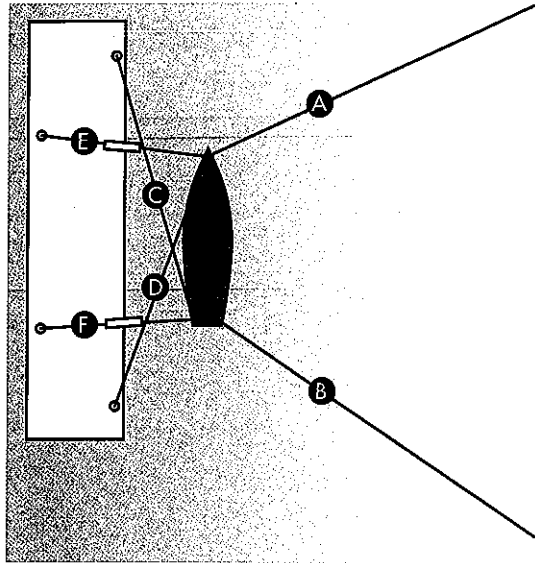

#### Moorings alongside a dock or bridge:

- Do not allow line to pull sideways on cleat; always lead line along the cleat by use of chocks.
  - Keep the boat off the dock. Do not rely on fenders.
  - Set bow and stern anchors (A&B).
  - Tie bow and stern spring lines (C&D).
  - Make sure lines E&F are long enough and equipped with chafing gear. Possibly run across pier with chafing gear.
5. Storm moorings, whether at dock or otherwise, should have doubled lines. The second set of lines should be a size larger than the normal lines, including spring lines at a dock.
  6. Purchase necessary materials ahead of time such as additional lengths of mooring lines, screw anchors, fenders, fender boards, chafing gear and anchors. These items may not be readily available during the hurricane season, or just prior to a hurricane.

#### Make sure your insurance policy is current.

7. If the vessel is to be unattended during the hurricane season, the vessel should be hauled at a storage yard or on its trailer, if trailerable. Making arrangements for wet storage at a protected dock, mooring or marina is another alternative.
8. Make up an inventory of all vessel equipment. Note items to be removed from vessel. Keep a copy of the inventory list both on board and ashore.
9. For wet berthing locations, ensure that seawalls and docks are sound, mooring bits and cleats are secure and dock pilings and dolphins are in good condition.
10. At private berthing and dock facilities in residential areas, check with neighbors and other

vessel owners in the area. Coordinate safety and mooring arrangement plans.

11. At marina facilities find out their hurricane plans and/or procedures with regard to vessels left at the facility from the dock master or marina management personnel.
12. Check with local marine and law enforcement organizations for local plans. This is especially important at boating centers in South Florida where access to inland protected rivers and canals is limited by bridges that may be closed permanently for land evacuation routes when a hurricane warning is issued.
13. If your plan calls for moving your vessel from its current berthing location to an inland waterway

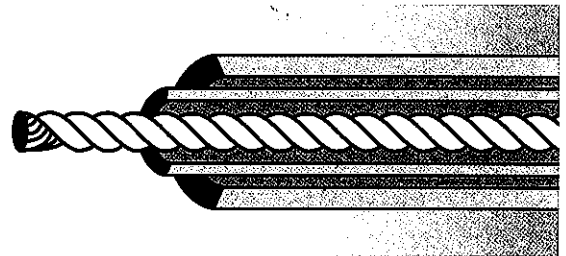

For a super system, if your chocks are large enough, fit a second, larger-diameter hose around another hose that fits snugly to the line. Drill holes in both hoses, and use cord to tie them securely to the line. In a pinch, you can use a single hose.

location, know your route, your vessel navigation requirements at different tides and the restrictions along the route such as bridges (auto and train) and channels. This is especially important for sailboats.

14. Rehearse your planned vessel movement, including an actual visit to the alternate dock or hurricane mooring/anchoring location. If rental of a protected dock or slip is required, make arrangements well ahead of time.

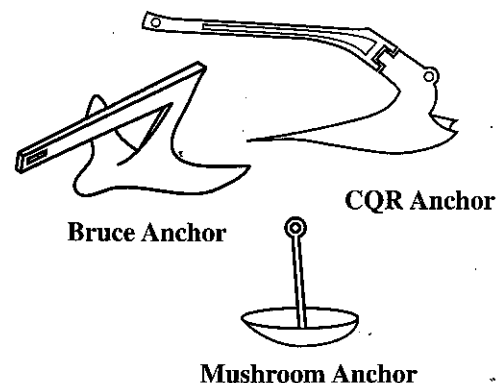

The bruce anchor will bury deeper as the boat pulls harder and hold in a 360° rotation. After surviving the storm, the anchor may be so deep it will have to be sacrificed.

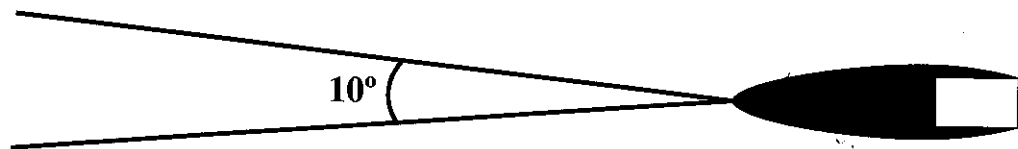
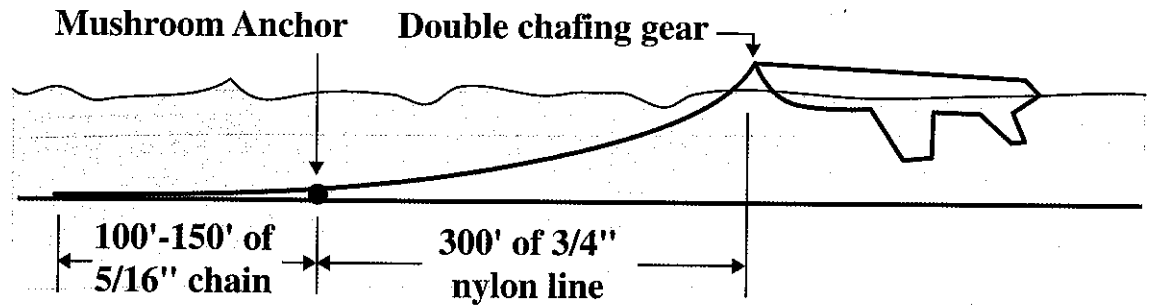

**Set two anchors at approximately a 10 degree angle**

**Galveston Bay Anchor System** – Set two bruce or cqr anchors on 100' to 150' 5/16" chain and 300 feet of three strand nylon line with a 50–100 pound mushroom anchor shackled on the boat end of the chain, attached to the boat with 3/4" nylon bridle with double chafing gear.

### Prior to the Hurricane

15. Be sure that family or key crew members know your hurricane plan or arrangements and that everyone who may be involved knows how to contact you or your designated representative or agent.
  16. Key your plan on quick response. Moving a vessel, stripping sails, derigging and anchoring in seas resulting from 35 mph winds is extremely difficult and impossible in 45 mph winds.
  17. Prepare your hurricane plan in writing and make copies of it. Keep a copy on the vessel and at home. Extra copies also should be made for the marina or yacht club facilities which may require you to have one on file with them.
  18. Make sure your insurance policy is current. Read the policy thoroughly. There is quite a bit of helpful and advisory information in the policy relative to what the vessel owner should and should not do if there is a storm- or hurricane-related loss or damage to the vessel. Understand the coverages, exclusions and your duties as a vessel owner.
1. If your plan calls for moving your vessel, and you have sufficient notice, do it at least 48 to 72 hours (or earlier) before the hurricane is estimated to strike the area. This may be before a hurricane watch is issued.
  2. Make sure that:
    - (a) fuel tanks are full;
    - (b) fuel filters are clean;
    - (c) batteries are charged;
    - (d) bilges are clean;
    - (e) cockpit drains are free and clear;
    - (f) fire-fighting equipment is in good order;
    - (g) lifesaving equipment is in good condition, in place and readily accessible.
 These items will be secured later.
  3. Remove and/or secure all deck gear, portable gear, radio antennas, outriggers, fighting chairs, deck boxes, bimini tops and side canvas/curtains, sails, boom, dorades, extra halyards, canister rafts and dinghies. Make sure that you secure all hatches, ports, doors, lazarettes and the sailboat rudder. (The dinghy may be required to take lines ashore.)



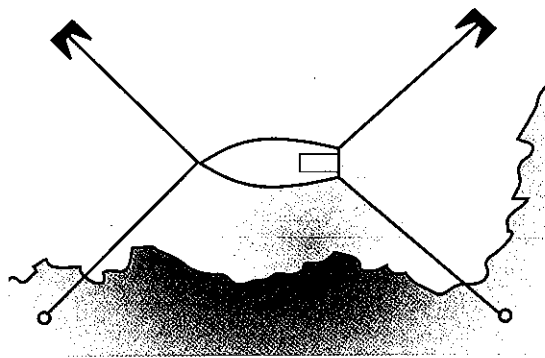

One of many possible arrangements that can be used to secure a boat in a hurricane hole.

4. If your vessel is moored at a dock on a canal, a river or in a marina near the ocean, it is possible that with an additional 5 to 10 feet or greater storm surge, the vessel could take a beating against the dock or even impale itself on the pilings.
5. The best offshore mooring location for a vessel to ride out a storm is in the center of a canal or narrow river where at least doubled mooring lines can be secured to both shores, port and starboard, fore and aft.
6. Do not raft vessels together at moorings or docks, especially if larger and smaller vessels are involved. The probability of damage to the vessels is greater than if they are moored singly.

### Do not remain on any vessel during a hurricane.

7. If the vessel must remain dockside at a private dock or marina, heavy-duty fender boards (2" x 6") should be used on a bare wood center piling, or otherwise installed to prevent damage. Lines should be doubled and even tripled where necessary to hold a vessel in the center of a berth, or off seawall or dock pilings. Preventers should be installed at the top of the pilings so lines cannot slip off the top. Note that nylon line will stretch 5 to 10% of its length.

Using the anchors, set 120° apart, allows the boat to swing and face the wind. This is an especially good technique in crowded harbors because the boat will not swing in as wide an arc as a boat that is riding on only two anchors.

## During the Hurricane

1. Do not stay aboard any vessel during a hurricane. If you have taken all the preliminary precautions previously outlined, you have done all that can be done in anticipation of the storm.
2. Stay in a protected and safe place. Attend to the safety of family, home and other personal property.
3. Stay tuned to news broadcasts and weather advisories concerning the hurricane so that you will know when the danger has passed.

## After the Hurricane

1. After the hurricane has passed, there may be extensive damage in the area. While checking the condition of your vessel is an important concern, there may be limitations such as flooded roads and downed power lines. A check of the vessel should be made as soon as practical to determine its condition and security.
2. Other vessels may be upriver behind your vessel's mooring location. This may require that you modify your mooring if you are in the center of a canal or stream so other vessels may navigate past you. If you don't, others may just cut your mooring lines and let your vessel drift, causing more damage than the hurricane.
3. A check of vessel security is important if damage has occurred. One security aspect that must be considered is the prevention of looters or others who feel that a damaged vessel is "abandoned" and, thus, theirs to take.
4. If there has been any theft, vandalism loss or damage to the vessel, other than storm-related, a report should be made to local police or other law enforcement authorities so that appropriate actions can be taken. The incident report number and, if possible, a copy of the incident report should be

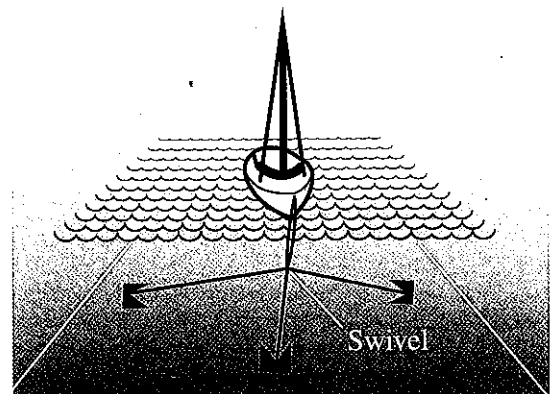

- obtained to substantiate any insurance claim or IRS property loss reporting.
5. If damages are incurred to the vessel, immediate action should be taken to save the vessel and/or equipment and prevent further loss or damage. This action is a requirement of all insurance policies. A vessel owner is expected to take those actions that a "prudent, uninsured person" would take to save and preserve his property.
  6. If the vessel appears to be unrepairable (constructive total loss), arrangements will still have to be made to remove the hull from any navigable waterway as this will probably be required by government authorities. The vessel should be moved to a yard or salvage facility storage area.
  7. If salvage removal of your vessel is required (emergency or otherwise), and you are unable to receive advice from your insurance company, agent, marina or yacht club, screen the salvage contractor for competence and cost. Read the contract, know where your vessel is going and the level of security provided at the location. Save as much equipment from the vessel as possible.
  8. Where vessel damages are repairable, immediate arrangements should be made with a reputable repair yard to have the vessel moved there, if necessary, for repairs. Make a list of repair facilities where you would like the work performed. Obtain estimates before proceeding with repairs. Those who act quickly will be back in the water first.

## Specific Precautions for Marina Owners

Marina operators, yacht dealers, boat builders and boat repair yards should consider the following information in formulating an overall hurricane plan for their facilities. Since facilities, circumstances and exposures vary throughout the country, adaptation of these suggestions to specific situations may be necessary.

### Prior to the Hurricane Season

1. Develop a formal hurricane plan and distribute to all employees. Facility personnel will have homes, family and property of their own to consider. They must be made aware of their work-related duties and responsibilities so that they can plan accordingly.
2. Know your physical plant facilities, operations services, equipment and housekeeping. Make assignments of personnel to be responsible for areas and operations of the facility. Designate team units to be responsible to key people.
3. Review plans and procedures with cotenants or subcontractors in multiple-occupancy facilities.
4. Review your facility's "seasonal" operations or activities during the hurricane season and consider ordering supplies, stocks and vessel inventory items accordingly to keep exposures as low as possible.
5. Consider the number of permanent, transient, new or brokered vessels that may be on hand in your care, custody and control at any period of time during the hurricane season. Can you secure all vessels at your facility, or will vessels have to be moved to inland protected areas? How and by whom? Where? These questions are best answered in calmer times, long before the storm.
6. Determine your policy on nonowned vessels in your care, custody and control at your facility or elsewhere. Communicate your position to vessel owners, preferably in written form as a notice or as part of the mooring, listing or work order agreement or contract.
 

Know all the vessels and their owners, captains or caretakers. You should have on record the home and business phone numbers and addresses of the vessel owners or their designated-representatives. Consider having vessel owners file their hurricane plans, in writing, with you.
7. Conduct a complete facility housekeeping and "field-day" or "field-week" operation sometime in the spring, or just prior to the hurricane season, to police and clean up all open areas and structures within the facility. This should include, but is not limited to, the following:
  - (a) Remove all debris, trash and unnecessary items from open areas.
  - (b) Store or otherwise secure all materials and supplies.

- (c) Inspect and service as necessary all building walls, roofs, windows, doors, docks, piers, wharfing or slipfingers, pilings, electrical and lighting installations, fuel and natural gas supply and dispensing equipment, both portable and fixed fire-fighting equipment, mobile lifts, hydrolifts and railways.
- 8. Order and stock as necessary emergency equipment and supplies that the facility warrants, such as extra mooring lines, lumber for fender boards, chafing gear, screw anchors, flashlights, batteries, portable generators, electrical and manual bilge pumps and hull patching or repair supplies.
- 9. Process and mail all paperwork that can be completed immediately. Set all new paperwork aside to be completed after the hurricane.
- 10. Remove expensive equipment or products to inland warehouses for storage.
- 11. Reduce inventories as much as possible and delay ordering materials, stocks or supplies.
- 12. Contact vessel owners or their representatives in order to begin removing vessels from the facility, if required.

### **Prior to the Hurricane**

Even the smallest marine facility operation has both numerous tasks that must be performed and precautions that must be taken in preparation of a hurricane. The extent of the tasks and the number of personnel available will determine the amount of time required to complete the preparation. However, 72 hours is probably the minimal time allowable in most instances to undertake the following procedures:

#### **A. 72 to 48 hours prior to Small Craft Warning conditions:**

1. Notify personnel that the facility is on a hurricane alert. Personnel should commence preparations for putting the hurricane plan in action.
2. Put any mobile or waterborne operations personnel on standby to start securing operations within the next 24 hours.
3. Begin facility protection preparations by policing all yards, marina and dock areas. Stow away or secure loose equipment.
4. Secure all flammable, explosive or other hazardous materials, such as compressed gas cylinders, in a safe, protected secure area.
5. Dry storage, or other facilities with outside "racks" for small boat and trailer storage, should consider removing vessels from racks and securing them elsewhere.
6. Facilities with inside "rack" storage in a building may provide sufficient protection unless in a lowland area where evacuation of all vessels may be necessary.
7. Take down large signs, antennas or other removable items subject to wind damage.
8. Facility protection precautions should commence at this time. Storm shutters or other protective

#### **B. 48 to 24 hours prior to Small Craft Warning conditions:**

1. Lowland locations that are evacuating personnel and equipment should complete securing operations. All dock structures, field buildings and offices should be secured. Trailers should be evacuated. All electrical power supplies should be secured by turning off power at the main power switch. All natural gas should be turned off at the main valve. All fuel supply tanks and lines should be secured at the shoreside installation. All electric motors, pumps and like equipment at, or below ground level, should be disconnected and protected or placed in a safe location. If fresh water is supplied from city water lines, turn off the supply at the meter. Notify the location manager, or local police, when the evacuation is completed and the location is secured.
2. All vessel removal operations should be well underway and completed during this 24-hour period. Plans for securing remaining vessels should commence.
3. As the departing vessels are fueling, facility vessels and vehicles should also be topped off, as necessary, in preparation for securing all fueling operations and equipment. Loss of electrical power during a hurricane may disrupt fuel supplies after the storm.
4. Any equipment, such as forklifts, trucks, travel-lifts, mobile cranes and workboats that may not be needed in storm preparations, should be secured in protected areas, shops or warehouses.

#### **C. 24 to 0 hours prior to Small Craft Warning conditions:**

In these hours prior to the projected arrival of the hurricane, the "Hurricane Warning" has been issued and it is highly likely that the hurricane will landfall near your facility. The following

activities should be in progress or nearing completion so that most personnel can be released in the next 12 hours.

1. All vessel protection and securing operations should be completed with a final check of doubled mooring lines, tied off with sufficient slack, and fender boards and/or other protective equipment in place.
  2. Employees who are not staffing facilities during the storm should be released no later than 12 hours prior to the storm. Instructions for reporting back to work after the storm should be given.
  3. Whether staffing or evacuating the facility, ensure that all perimeter access points, in the form of fences, gates and building doors, are locked and secured.
  4. All facility precautionary preparations should be completed 12 hours prior to the hurricane's arrival.
  5. No personnel should be allowed to stay on any vessel during the hurricane.
- (b) Be aware of possible downed electrical wires which should be considered "Hot" and avoid these areas until the power company or electrical maintenance personnel are notified. Although your house or boat may be without power, generators may be operating and the electrical lines will be charged.
  - (c) Checks should be made for leaking natural gas by smell only, not with matches or candles.
  - (d) Facility fueling docks and tanks should be checked for leaking gasoline or diesel fuel.
  - (e) Electrical equipment at the facility that has been submerged in water should not be started until it has been checked and repaired as necessary.
  - (f) Broken sewer or water mains should be reported immediately to either the utility company responsible for repairs or to the maintenance personnel, if owned and maintained by the facility.
  - (g) Building, shop and dock electrical wiring should be checked completely prior to turning on the main power switch.
  - (h) Wet electrical appliances such as hot plates, toasters, calculators, typewriters, etc., should be inspected and repaired or replaced as necessary, prior to operation.

### **During the Hurricane**

1. Stay in a protected and safe place inland if possible.
  2. For facilities remaining staffed, extreme caution should be exercised if outdoor activities become necessary.
  3. No one should attempt to move or resecure a loose vessel or equipment during the storm period.
  4. Stay tuned to news and weather broadcasts concerning the hurricane's movement so you will know when the danger has passed.
  5. Do not venture out during the "eye" or lull in the hurricane.
3. Prepare a written assessment of damages as soon as possible. Estimate damages to docks and piers and other harbor facilities; cranes, mast hoist, boat sheds, toilets, showers, lockers, the Harbor Master's office, fuel dock and office, electrical transformers, electrical service and telephones.
  4. If there has been any theft, vandalism loss or damage to the facility, other than storm-related, a report should be made to local police or other law enforcement authorities so that appropriate actions can be taken. The incident report number, and if possible, a copy of the incident report, should be obtained to substantiate any insurance claims or IRS property loss reporting.

### **After the Hurricane**

1. The hurricane may cause extensive damage, flooded roads, downed power lines and washed-out beach or river areas. While checking the condition of your facility is of main concern, there may be limitations which may impede you from accessing it.
2. As personnel return to the facility and begin the preliminary damage assessment process, they should be aware of the following potential problems:
  - (a) Beware of snakes when going into grassy areas or other locations. Personnel should wear boots and be cautioned to look where they place their feet and hands.
5. While it is understandable that immediate repairs may need to be undertaken, all actions taken during the course of repairs prior to any insurance adjustment should be documented properly and filed. In the case of facility property damages, appraisers assigned by the insurance company will be involved in assisting with the adjustment. Insurance companies will establish storm claim offices to handle the numerous claims after a hurricane strikes.
6. It is obvious that third-party vessel owners will inquire as to the status of their vessels. These inquiries should be fielded as best as possible, especially if there is no damage to their properties.

Notification of any vessel damage should be made as soon as possible.

7. While vessel owners may want to return to marinas or yard facilities as soon as possible, they should be advised as to the situation at the facility and the availability of berthing facilities for their vessels. If damages preclude the facility from providing a berthing space for the vessels, owners should be so notified and advised as to when the facility may be available to provide a berth.
8. If the facility is relatively undamaged, then efforts should be made to become operational and provide facility services to those who are not so fortunate.
9. Controlled access and/or security at a facility may be required. Plan how to handle:
  - (a) members and nonmembers in the case of yacht clubs
  - (b) tenants and nontenants in the case of marinas or other facilities
  - (c) radio, television and press representatives
  - (d) outside salvage contractors, repairers, estimators, surveyors, adjusters and appraisers

There may be many other actions and precautionary measures that can be taken prior to, during or after a hurricane strikes an area. The information above may not cover all actions that should be taken, but is provided as a guideline and checklist that can be a starting point for developing a hurricane plan.

If there are specific measures or precautions unique to your operations, then fit them into the checklist when preparing the plan for your facility.

Only by being prepared in advance will you be able to reduce loss and damage as a result of a hurricane.

### Correct method of making fast to a cleat

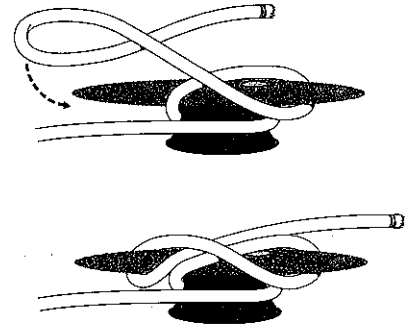

**Clove hitch**

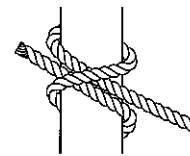

# General Procedures to Process Vessel Claims

Once you determine you have a loss, the following steps should be taken to process your claim:

1. For the record, photograph the damaged vessel and make a list of all damages and suspected problems. If the vessel is in danger of suffering further loss, take all necessary steps to preserve the vessel and prevent further damage. Do not begin repairs other than those necessary to prevent further damage.
2. Promptly call your insurance agent to report the claim or loss. Estimate the percentage of damage – cosmetic, water damage, total loss, etc.
3. Contact repair yards to get estimates for repairs. You do not have to wait for an adjuster/ surveyor to get estimates.
4. An adjuster, insurance company surveyor or independent surveyor acceptable to the insurance company will be instructed to survey the damaged vessel. The boat owner can elect to hire a second surveyor, at his own cost, to conduct an independent survey of the vessel. The boat owner should arrange to accompany the surveyor on the initial damage survey.
5. Have your inventory list, receipts, inventory
10. When the work is completed to the boat owner's satisfaction and approval, the check is cosigned and the repair firm is paid.
11. Keep in mind that, with all the confusion accompanying the aftermath of a hurricane, the underwriters will first settle claims having all the appropriate paperwork completed.
12. If a total loss of the vessel exists, a check is issued by the insurance company to the boat owner and mortgagee – usually for an amount equal to the agreed value, or the fair market value of the vessel.
13. In the event of a total loss, be prepared to surrender the vessel's documentation papers, original insurance policy, any remaining equipment and the damaged vessel.

## Promptly call your insurance agent to report the claim or loss.

pictures, pictures of damages and repair estimates ready for inspection by the adjuster/surveyor. You will need to provide both a "proof of loss" and "release/payment order."

6. After conducting the survey, the surveyor files a surveyor's damage report with the insurance company, and sends a copy to the boat owner, if required.
7. The boat owner files a statement of loss with the insurance company explaining what took place, when, where and why. It includes specific lists of known damages along with sketches or drawings.
8. In the event of a dispute, the boat owner will hire a second surveyor/adjuster, at the boat owner's expense, to represent the owner's side of the dispute. A third party will be designated to listen to both sides and arrive at a decision.
9. If the boat owner agrees on the estimates and the company designated to do the repairs, the insurance company issues a check with both the repair firm and boat owner/mortgagee listed as payees on the check.

## Remember!

If a vessel is insured and damages have occurred, a report of loss and/or damage should be made to the insurance agent and/or company as soon as possible. A telephone call will suffice to put them on notice. This should be followed up with a written notice. Provide all the details that you can on this first notice, such as:

- (a) exact location of vessel
- (b) structural condition of vessel (e.g., holes in hull or minor damages)
- (c) did the vessel partially sink and is the machinery and/or interior wet?
- (d) must the vessel be removed immediately; if so, to what location?

## **Be Aware!**

Insurance companies will have surveyors and adjusters in the area to assist and work with their policyholders. In locations designated as disaster areas, there will be insurance teams and claims offices established. While surveyors, adjusters, company representatives and many repair facilities will try to work with you, only you have the right and authority to determine what is to be done to or on your vessel. There will be many boat owners with damaged vessels, and repair facilities will be very busy. You will have to do the necessary preliminary work quickly to get your vessel repaired.

## **Summary**

### **Important Points to Know**

- Develop your hurricane weather plan early. Only you can be responsible for your plan.
- Make all arrangements for moving and securing your vessel prior to the hurricane season.
- Do not stay on your vessel, or attempt to move or secure your vessel after small craft warnings have been posted. Marine agencies will pull their vessels from the water when wind and seas warrant. They will not risk their lives to rescue careless boaters.
- Stay tuned to all broadcasts and official bulletins until the storm has fully abated.
- Do not return to your vessel until the hurricane has cleared your area and you are told that it's okay to return.
- Do not allow yourself to become a hurricane statistic! Your life is more valuable than your property.

For further information on other publications provided by INAMAR Recreational Marine, please visit us at:  
[www.INAMARmarine.com](http://www.INAMARmarine.com)

This brochure contains general information only. The information has been gathered from various sources believed to be reliable, but it is not intended to be a substitute for advice from a safety expert or legal counsel.